

HARDWOOD FLOORING WITH GLUE-FREE 5G® LOCKING SYSTEM

INSTALLATION INSTRUCTION 5G®

This document only gives you basic information when installing a floating wood flooring with 5G®locking system. For more detailed information concerning the installation or maintenance of your new floor, you must visit raw-products.info

LÆGNINGSANVISNING 5G®

Dette dokument giver dig kun grundlæggende information til lægning af svømmende trægulve med 5G®-låsesystem. For mere detaljerede oplysninger om installation eller vedligeholdelse af dit nye gulv, skal du besøge raw-products.info

LEGGEANVISNING 5G®

Dette dokumentet gir deg bare grunnleggende informasjon om flytende legging av tregulv med 5G®-låsesystem. For ytterligere informasjon om installasjon eller vedlikehold av gulvet, må du besøke raw-products.info

LÄGGNINGSANVISNING 5G®

Detta dokument ger dig endast grundläggande information vid flytande läggning av trägolv med 5G®-låssystem. För ytterligare information kring golvläggning eller skötsel av golv skall ni besöka raw-products.info

5G® -ASENNUSOHJEET

Tämä asiakirja antaa sinulle vain perustiedot asennettaessa kelluvaa puulattiaa 5G®-lukitusjärjestelmä. Tarkempia tietoja uuden lattian asennuksesta tai kunnossapidosta on käymällä verkkosivustolla raw-products.info

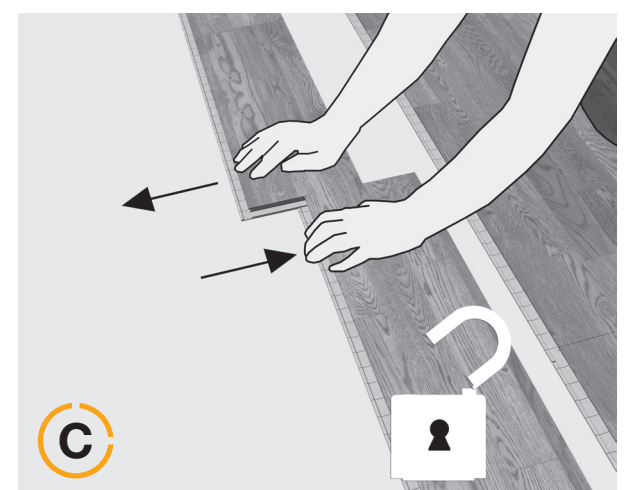
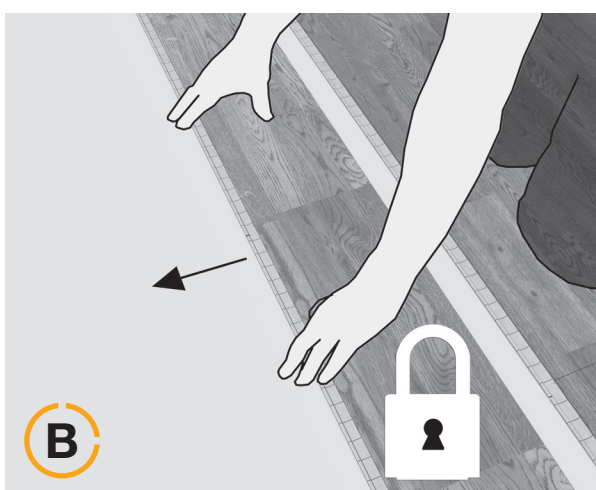
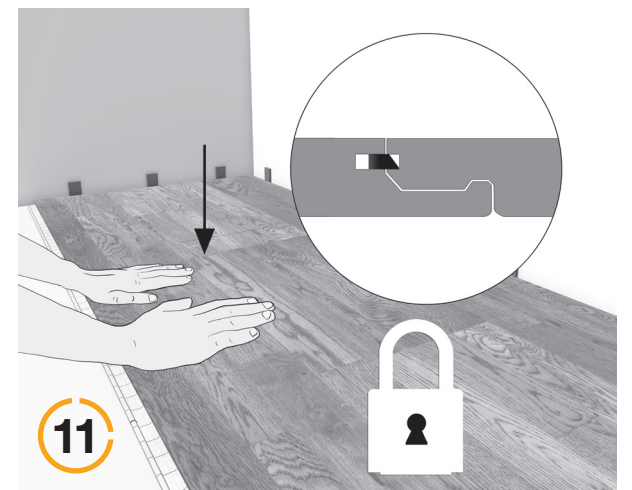
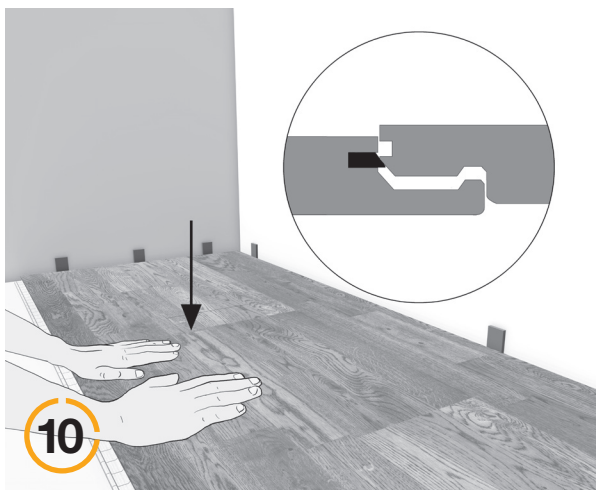
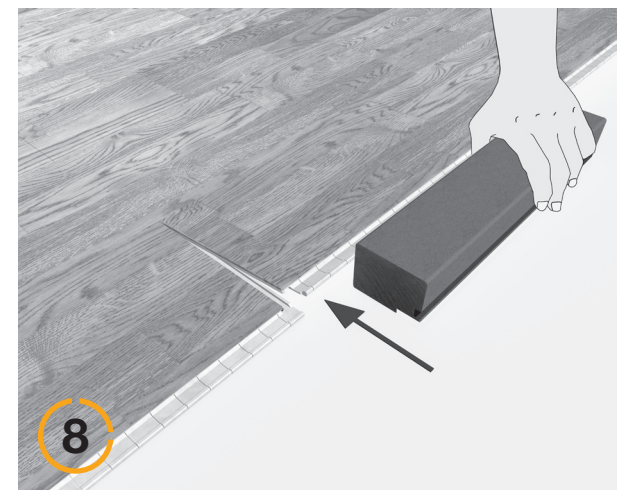
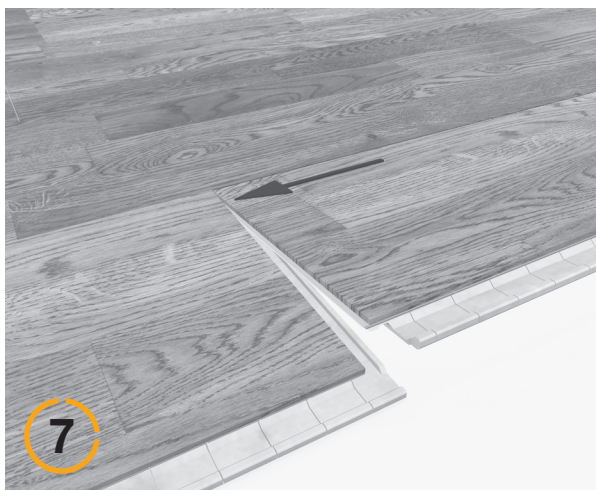
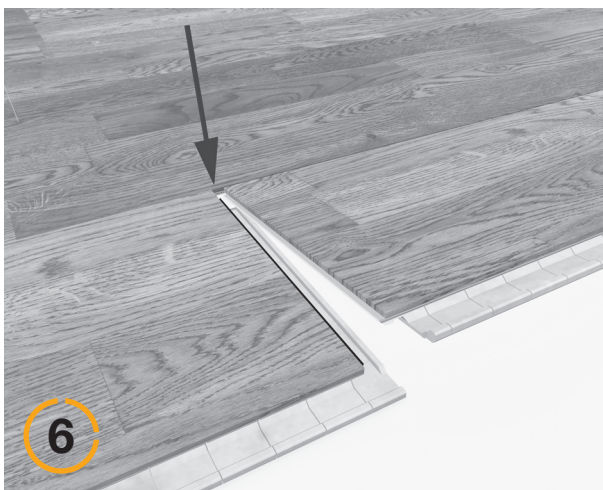
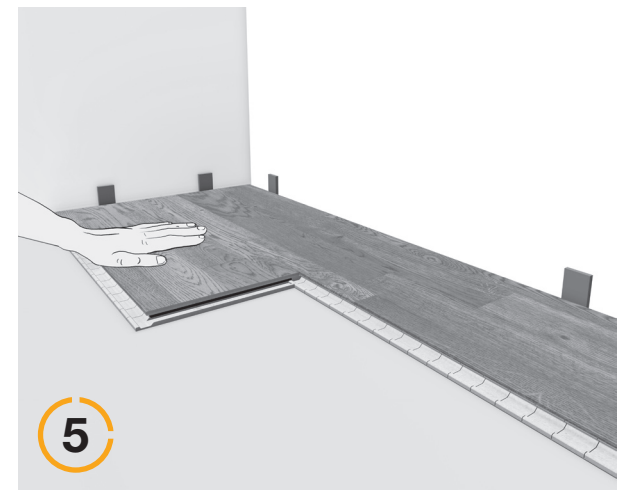
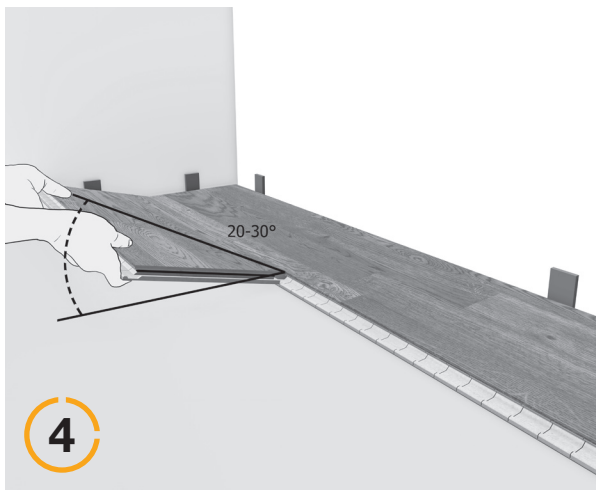
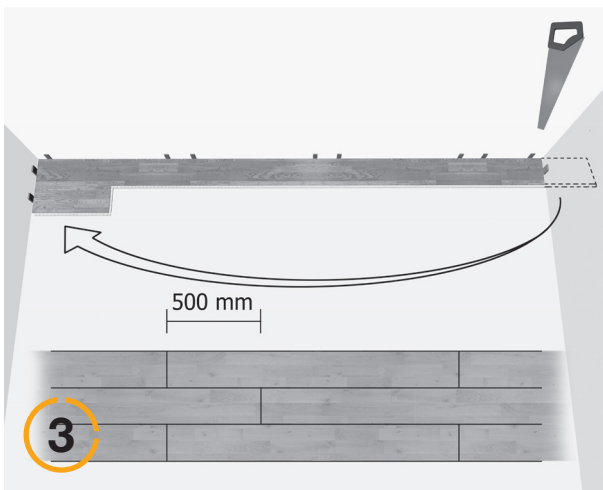
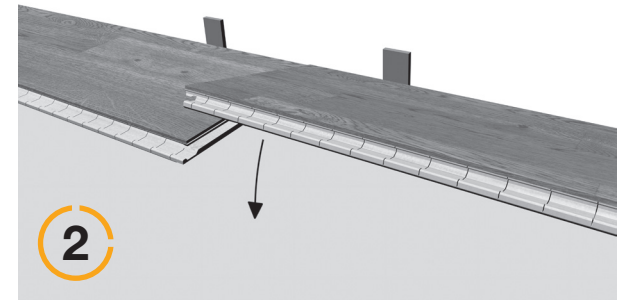
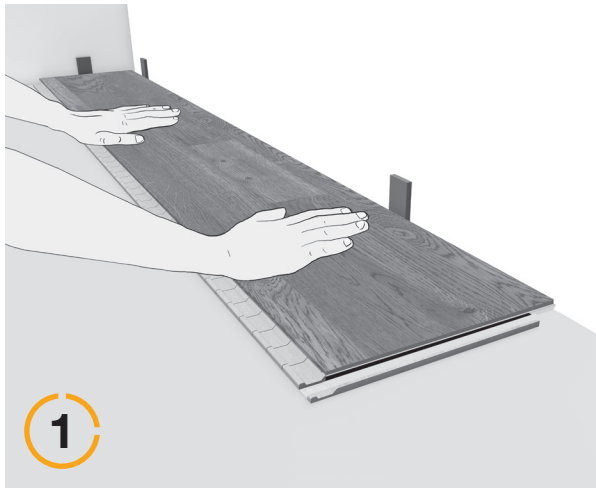

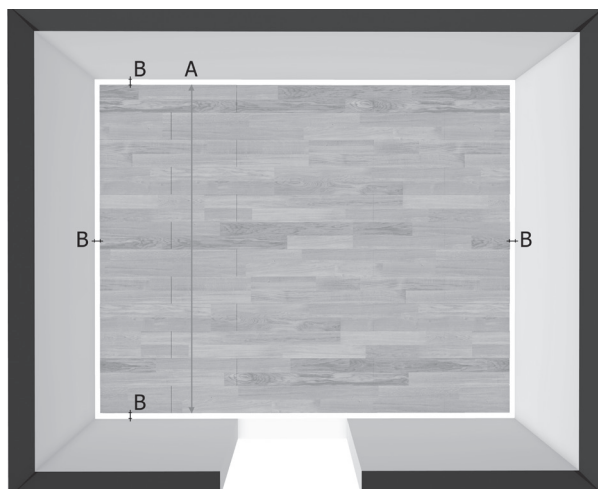
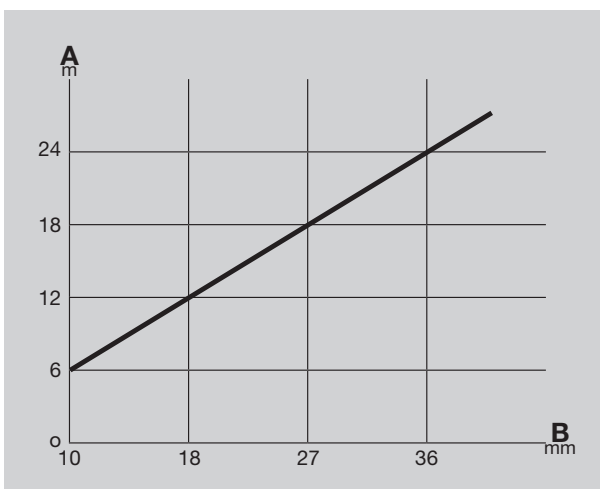
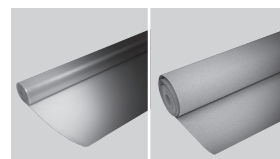
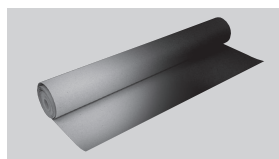
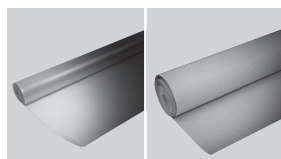
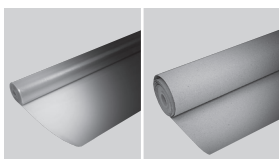
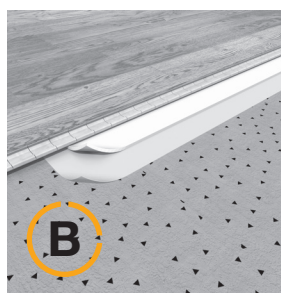
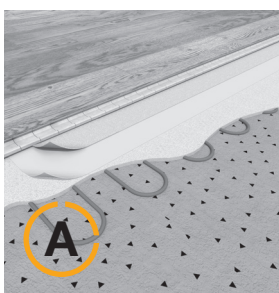
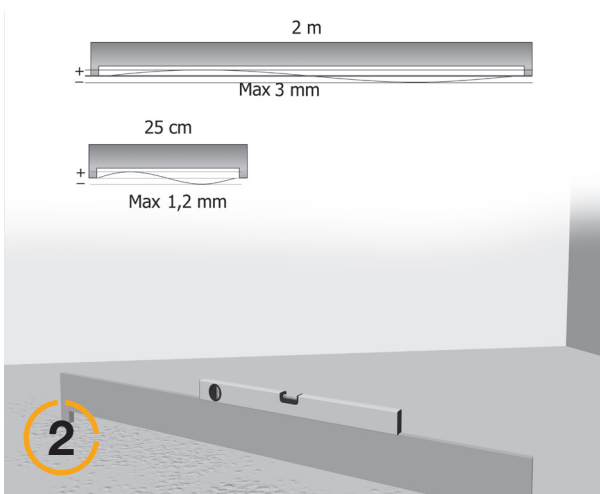
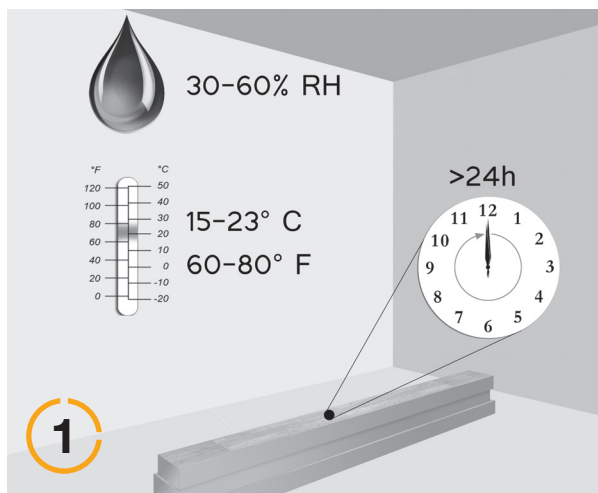
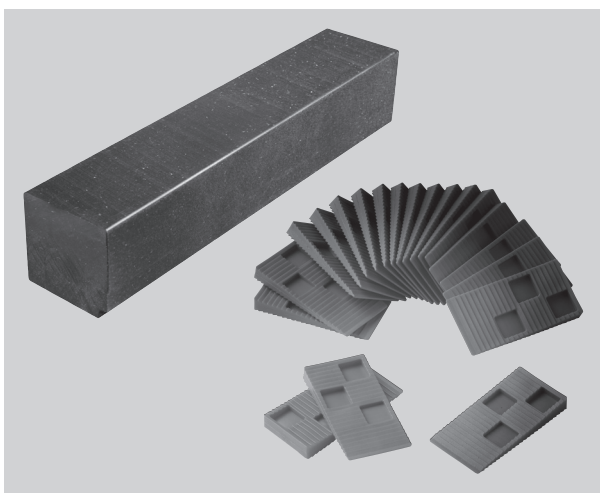

HARDWOOD FLOORING WITH GLUE-FREE 5G[®] LOCKING SYSTEM

Laying instructions
 Monteringsvejledning
 Leggeanvisning
 Läggningsanvisning
 Asennusohje



3029 0012



Fold down locking system

 20	
DOP_RAW_Parquet_KA122019 EN 14342:2005+A1 2008	
RAW A/S Skanderborgvej 277 8260 Viby J. - DK www.raw-products.info	
Floor covering for internal use in dry conditions	
Thickness: See label Moisture Content: 7% ± 2% Min. Mean Density: >500 kg/m ³ Reaction to Fire: Dfl -s1 Formaldehyde Emission: E1 Pentachlorophenol: < 5 PPM Slipperiness: NPD Therm. Conductivity 14mm: 0,11 W/mK Therm. Conductivity 15mm: 0,13 W/mK Biological Durability: Class 1	   

5G[®] is a patented technology invented by Välinge Innovation AB. The 5G[®] word mark and logo are registered trademarks owned by Välinge Innovation AB and any use of such marks is under license.